

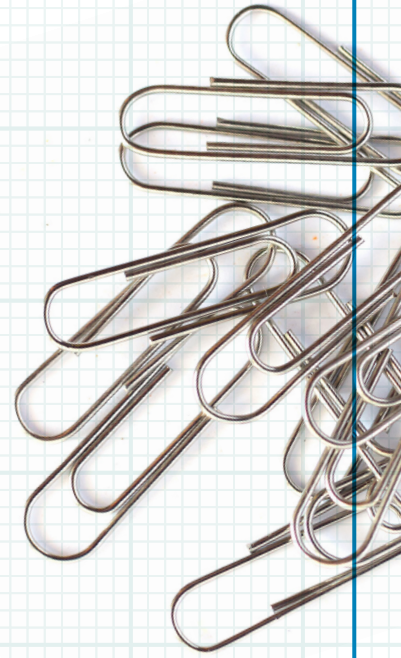

power to
change

business in
community
hands



Targeting funding to support community-led housing

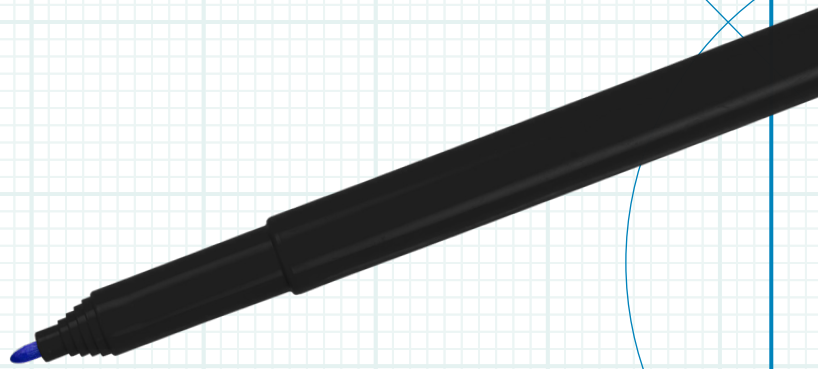

A report prepared
for Power to Change

WRITTEN BY:

Tom Archer
Anna Kear
Catherine Harrington

DATE:

August 2018

SUPPORTED BY:



**NATIONAL
LOTTERY FUNDED**

Contents

| | |
|--|----|
| 1. Introduction | 2 |
| 2. Stages of a community-led housing development | 4 |
| 3. The funding, finance and support needs at different stages of development – the Total Process | 6 |
| 4. Current provision of funding and financial support | 10 |
| 5. Future government funding and the growth of the community-led housing sector | 15 |
| 6. Forecasting growth in community-led housing | 16 |
| 7. Emerging findings and implications | 18 |
| Appendix 1: Community-led housing development process | 20 |
| Appendix 2: Funding and finance landscape | 23 |
| Appendix 3: SWOT analysis of funding for development stages | 26 |

About this working paper

This report seeks to look at the objectives of Power to Change's community-led housing (CLH) funding programme, and brings together evidence which will help target Power to Change's interventions. Looking first at the Development stages of CLH groups, and their funding and support needs the report then maps the current landscape of (and gaps in) funding and finance for such schemes. The authors offer an assessment of the the potential growth of the CLH sector.

About the authors

Tom Archer

Tom has 15 years' experience in a variety of research and policy roles in housing and regeneration. This includes managing a European street homelessness initiative as well as research projects for central government, a large housing association and local authority housing departments.

Tom's PhD focused on the development of community-led housing in England, as a response to the current housing supply crisis. His recent academic work focuses on trends in profit-making and housing output by the largest UK housebuilders. Tom joined the housing team at the Centre for Regional, Economic and Social Research within Sheffield Hallam University in 2017.

Catherine Harrington

Catherine has been the Director of the National Community Land Trust (CLT) Network since it was established in September 2010 and she has been instrumental in the Network's lobbying and campaigning. Catherine previously worked in housing policy at Department for Communities and Local Government. Prior to that she worked at Notting Hill Housing Trust and at the Institute for Public Policy Research.

Catherine has an MSc in City Design and Social Science from the London School of Economics and a BA Hons in Social Anthropology from the University of Cambridge.

Anna Kear

Anna has worked in the housing sector for over 30 years in a broad range of roles within Aster Group, local authorities, housing associations and private sector house building organisations. She has also been a Board member of Wiltshire CLT and Bath Self-help Housing and is now the CEO of Tonic Housing, an organisation aiming to reduce isolation and discrimination of older LGBT+ residents. Anna also recently acted as Executive Director of UK Co-housing where she worked to make co-housing projects easier to achieve, more affordable and to raise awareness of their benefits.

1. Introduction

Over the next ten years Power to Change will support community businesses to ‘transform places through positive economic, social and environmental impact’.¹ Toward this aim, Power to Change are developing a programme to support community businesses engaged in community-led housing (CLH) in England. This report is intended to shape the design of this programme, and specifically seeks to detail the support, funding and finance needs of CLH groups, and whether the current provision of such resources is meeting these needs. It sets out details and suggestions about how the Power to Change programme can have maximum impact and affect the aspired growth of the CLH sector.

For the purposes of this report, the definition of CLH being used is that endorsed by the sector, whereby:

- There must be meaningful community engagement and consent. The community does not necessarily have to initiate and manage the development process, or build the homes themselves, though some may do;
- The local community group or organisation owns, manages or stewards the homes in their own way; and
- The benefits to the local area and/or specified community must be clearly defined and legally protected in perpetuity.

Whilst organisations undertaking CLH might adopt a variety of legal forms, the term ‘CLH’ covers a variety of operational models such as Community Land Trusts, Development Trusts, Cohousing groups, Housing Co-operatives, Self-Help Housing organisations and group self-builders.

CLH is a growing activity in England, yet significant barriers remain that prevent the sector from making a more meaningful contribution to housing supply and to the resilience and sustainability of communities. These include access to technical support for volunteers; access to land at an affordable cost; access to affordable capital finance and access to retail mortgages. In addition, the sector suffers from being fragmented and relatively uncoordinated.

¹Power to Change (2016) Better places through community business: Our strategy 2016–18

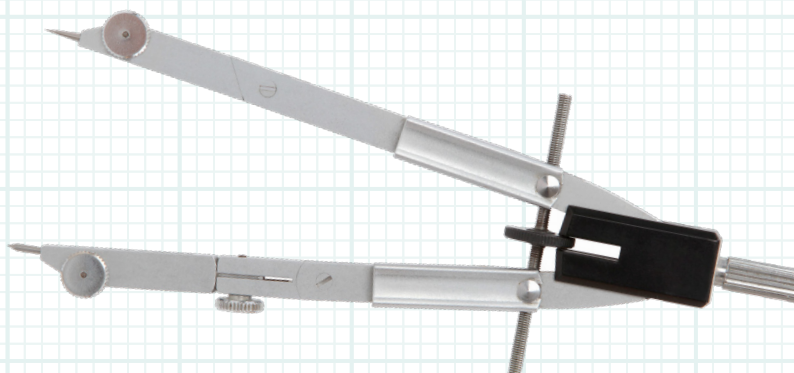

Power to Change acknowledges it is entering a field in which there are a variety of other funders acting in relatively disjointed ways, and this is becoming more complex with the introduction of dedicated central government funding for CLH schemes. Allowing for some flexibility in responding to this rapidly changing environment, Power to Change has set some outline objectives for their CLH programme:

- Simplify the process of CLH development
- Build an effective and sustainable infrastructure of support
- Develop a funding programme which helps groups transition between different funding and finance, which is appropriate for their stage of development

This report seeks to refine this thinking, and brings together evidence which will help target Power to Change's interventions. We start by clarifying the Development stages of CLH groups, and outlining their funding and support needs. This is critical as groups experience different challenges and needs at different points in their development. We then present a mapping of the current landscape of funding and finance for such schemes, pin-pointing specific gaps in current provision. Following this we assess the potential growth of the CLH sector, offering a scenario of growth if an effective infrastructure and funding regime can be developed. In conclusion we offer of a summary of findings from this work, with more detailed information provided in the Appendices.

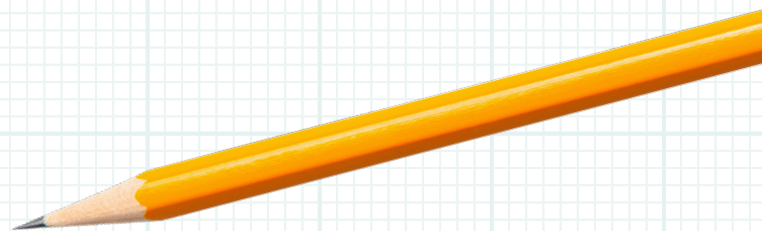
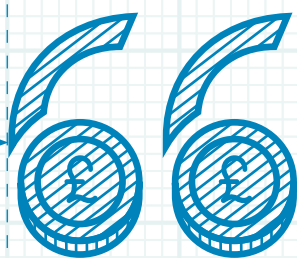

This report seeks to refine this thinking, bringing together evidence which will help target Power to Change's interventions.

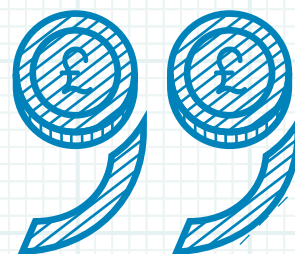

2. Stages of a community-led housing development

A variety of different terminologies is currently used by funders to describe the stages of development (of both new build and refurbished homes) of a CLH project, e.g. 'pre-feasibility', is not an industry standard term and therefore adds to the confusion in the funding landscape. There is now an opportunity to move the sector towards adopting terminology of the stages in housing development that is standard in the industry. There are also stages that are unique to CLH. All these stages have been identified below. Clarity on these stages enables an assessment to be made of the current availability of and gaps in support and funding available for each.

We have identified five stages of CLH development, each of which contain specific functions which are visualised in the attached appendices ('Appendix 1: CLH Development Process – key stages'). This will require some further refining and testing with CLH groups, if the new approach is to be adopted:

1. Group

This relates to all the functions of CLH that are distinct from mainstream housing development. Each CLH group has to form, be constituted, define and set out how it will operate and finance its objectives. This goes for every specific CLH project, however, some groups may then go on to develop further projects or may themselves be an existing community organisation that is moving into developing housing, thus saving time and money repeating these functions. The Group functions continue throughout all the other stages of development.

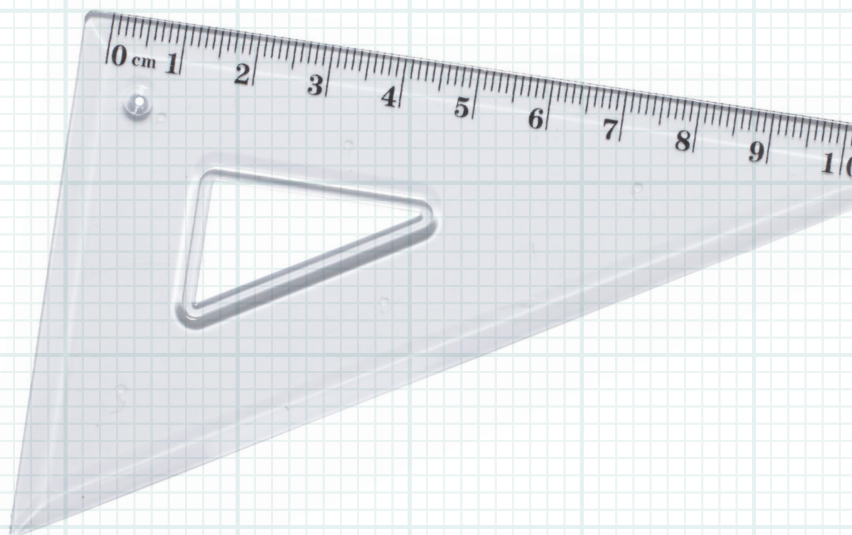
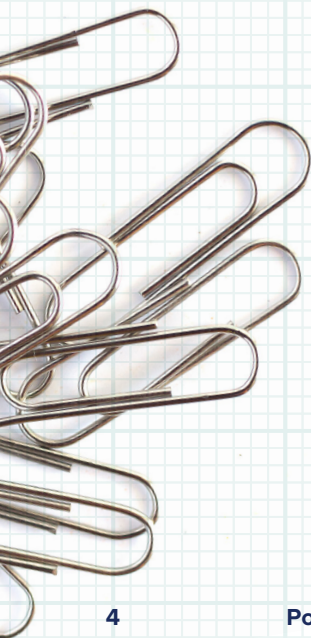



2. Site

This stage is about all the functions that relate to finding and acquiring a site for development, or a building for redevelopment. The functions are all industry standard but the financing of the site acquisition is not like mainstream development, where it has to be sourced rather than it being built into the standard business model.

3. Plan

This is all the functions leading to obtaining a planning consent for development and entering into a contract. The functions are all industry standard but, unlike mainstream developers, many of the tools need to be created or acquired by the CLH group such as standard specifications, sourcing and negotiating terms of development finance and budgetary control.

4. Build

This relates to all the functions involved in the build process. This is industry standard but is more akin to Housing Association procurement of build than house builders in terms of the contractual relationships required.

5. Live

These functions relate to the occupation of the homes once built and the functions required to enable occupation and on-going management. Some of these functions are industry standard such as sales and lettings, whilst others may interact with the Group functions if there is going to be continued community stewardship built into the project.

The first two stages, Group and Site, are not always realised in linear order, for example some CLH may be initiated by a site opportunity and therefore the Group activity operates alongside the Site functions. The other parts of the process do however tend to operate in a linear form, albeit with fuzzy boundaries of one work stream leading into another. The funding of these stages can therefore be reasonably expected to flow one from the other and be based on a certain level of tasks achieved at each stage.

3. Funding, finance and support needs at different stages of development – the Total Process

Using the above stages, we can identify the funding, financing and resources needed to support CLH development at each of these different stages, as part of a Total Process. Illustrating the Total Process can facilitate a streamlined approach to resourcing and financing CLH, enabling clear parameters to be set that need to be achieved at each stage to access the next stage of resources and funding.

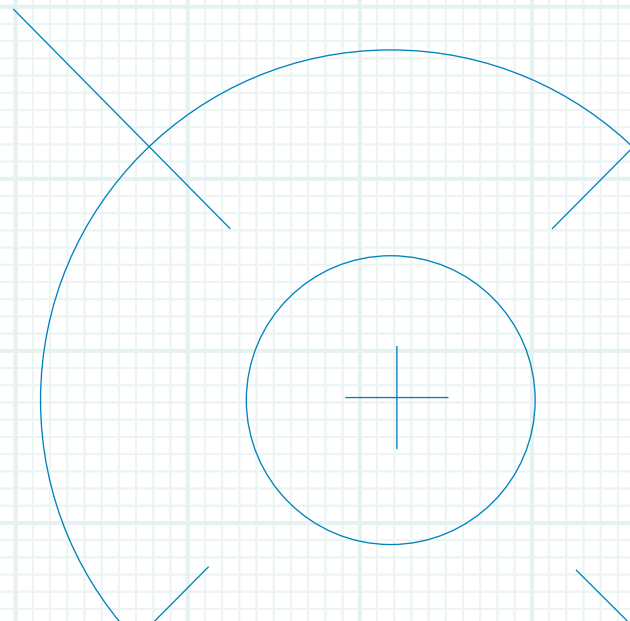
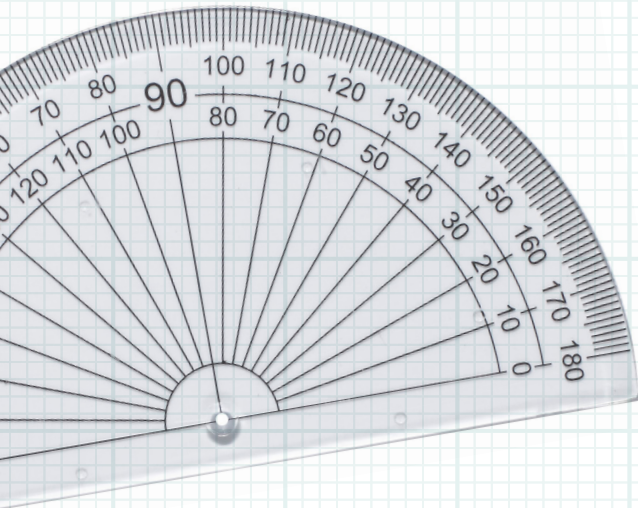
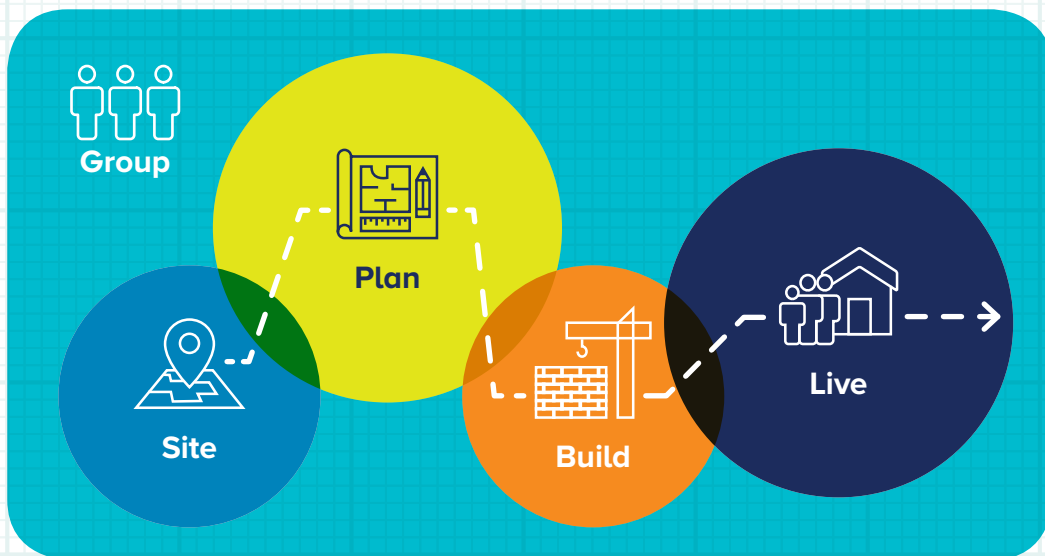

Throughout the different phases of their development, CLH groups require the following:

Group: Ongoing advice and support by an enabler that is knowledgeable and experienced in the development of CLH groups, in terms of their constitution, governance, community engagement, external relations and business planning. Some of this information will be specific to the local area such as local planning policies, the political context, the local housing market and local partners. Experience has shown that there is value in CLH groups being able to access these resources free at the point of use, prior to them being in a position to acquire funding or finance for the subsequent stages of development. Where this has not been the case, time and resources can be wasted at an early stage in having to apply for funding to get started. There is also value in capturing the learning and local social capital created through this process to facilitate further CLH development or scaling out.

It should be noted that the above support will need to be supplemented by professional advice from lawyers on incorporation, as well as, potentially, advice from housing development experts on costs, risks and partnership options. Newly forming CLH groups will also usually require some initial seed corn funding to cover early costs such as for incorporation and community engagement.

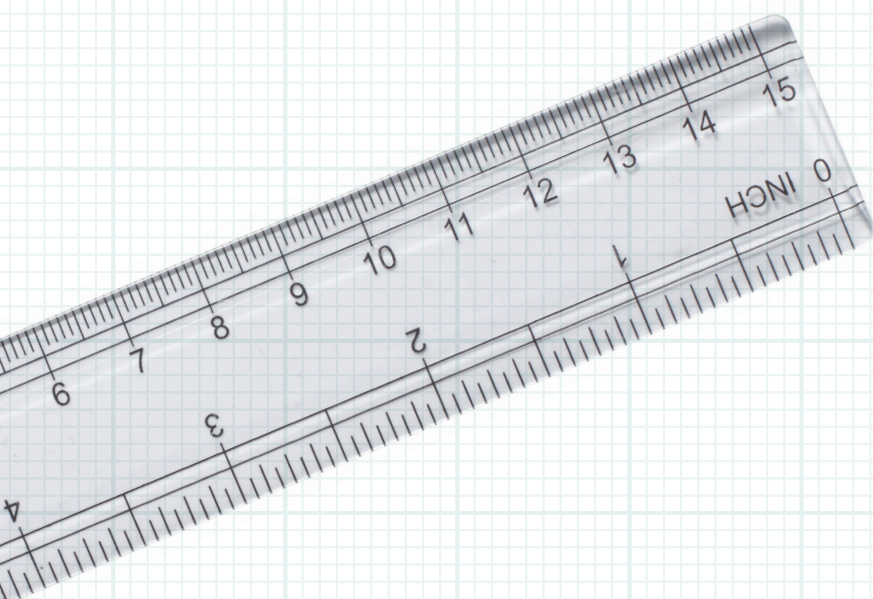

Site: The resources required for this stage are a range of professional services covering site identification, the feasibility of development, due diligence and the acquisition of the site. CLH groups generally need to raise finance to pay for these services and/or source them on a pro-bono basis. The costs for these activities can be capitalised into the development if it is successful.

The financing of the site acquisition itself is separate from the funding of resources to facilitate the acquisition. Some solutions to the cost of land can be long term leasing, securing an option to purchase or an agreement to build under license, which enables groups to make a payment at the build completion. Loan funding for land purchase can be problematic as the land is likely that an asset, in this case land, will be required to secure development finance. Community share issues can play an important part in the funding landscape and wider involvement, but this can take time to set up and could be facilitated to make this more efficient.

Plan: This stage requires a range of professional services concerning the detailed design of the development, the planning and infrastructure requirements, costing and contracting the build. Finance is also required to meet the cost of a planning application and any surveys that may be required to be commissioned as part of. CLH groups generally need to secure the funding for these services and 'at risk' costs, which may be in the region of hundreds of thousands of pounds depending on the size of the project. The costs for these activities can be capitalised into the development if it is successful, enabling the potential funding for the Plan stage to be a revolving loan facility. The 'risk' of these costs not being repaid can cause high interest rates to make the development prohibitively expensive, as is the case with the CAF Venturesome community land trust (CLT) Social Investment Fund. However, ensuring high quality of advice at the Group stage can reduce the risk levels to an affordable rate. Background information on previous success rates of CLH to inform probability of success vs failure could be helpful to inform current assumptions, although CAF Venturesome did find that their 25% failure rate was accurate in the pilot fund from 2008 to 2013.

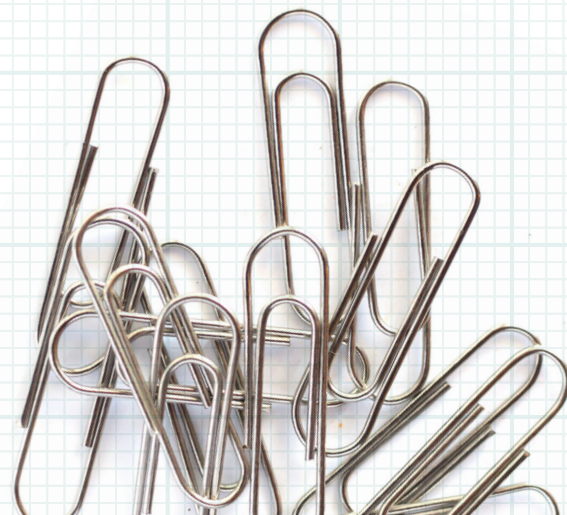

Build: This stage also requires a range of professional services concerning the management of the construction phase, including financial management, quality control and contract management. CLH groups generally have to secure loan finance and grant funding for the construction and these associated services. At this stage there is more certainty, although appropriate advice on contracts in the previous stage will mitigate the exposure to cost and time over-runs.

Live: This stage interacts with the Build stage as securing the finances for individual occupation needs to take place concurrently with the build to avoid any non-occupancy costs post completion. The finalisation of ongoing management arrangements, sinking funds and service charges need to be undertaken towards the end of the Plan stage to enable cost certainty to the occupiers. Availability of mortgage finance and long-term loans for rental are critical in the affordability and accessibility of the homes being developed. Given the limited number of retail mortgage providers who will lend on CLH homes, it is vital that the mortgageability of the home is considered early on in the process through discussions with potential lenders.

The Total Process: Clarifying the CLH Development stages and the functions undertaken within them can enable funding and financing to be developed as part of a Total Process, showing the flow of activity from one stage to the next. This approach enables appropriate due diligence and risk mitigation at each stage to facilitate the success of the next. For example, becoming a constituted group with a sound business plan enables access to funding for the Site stage; securing a legal interest in a site or property support by a sound development feasibility appraisal enables access to funding for the Plan stage etc.

An ideal approach to the Total Process would be a clear understanding that the funding is available at each stage if the published parameters are met. This could contribute substantially to both simplifying and speeding up the delivery of CLH.

4. Current provision of funding and financial support

Given the above stages of development and the associated support, funding and finance needs, we might ask if the current provision of these is adequate. Our research into the support and enabling infrastructure for CLH is ongoing, but we have also undertaken a detailed mapping of the current national landscape of funding and finance, which is provided in full in the attached appendices (see ‘Appendix 2: Funding and finance landscape’). Below we provide our analysis of this mapping exercise, identifying potential gaps and inadequacies. Also attached are several SWOT analyses of current funding and finance for each of the CLH Development stages (see ‘Appendix 3: SWOT analysis of funding for Development stages’).

Three questions arose when exploring this landscape of funding and finance;

- 1) Is there funding available for all of the CLH stages?
- 2) Is there sufficient quantity of funding available for each of the stages?
- 3) Is the available funding and finance structured in the right way?

Below, we explore each of these questions in turn.

4.1. The availability of funding and finance available for each stage of development

Our mapping reveals that there is at least some funding and finance available for various stages of CLH development. However, variation exists geographically, in terms of the availability of grants for certain CLH activities, the type of tenure/ housing model that the funding or finance supports, and the type of CLH group applying. For instance, there is a well-developed system of support for CLTs, which has been well-utilised and applied in certain locations (e.g. East Cambridgeshire). However, a group wanting to develop an alternative type of CLH, in a location where there is little experience and support for CLH, may find the environment particularly challenging. This draws attention to the inter-relation between funding, the provision of support and enabling services, and also the receptiveness of other stakeholders in local environments. What is clear is that, when looked at in the round, the myriad funding and finance available for CLH seems uncoordinated and siloed, intervening in ad hoc ways, rather than as part of a joined-up strategy.



Putting aside the issue of whether the quantum of any funding and finance is sufficient, and whether it is structured appropriately (see below), we can look at a number of active funders supporting CLH groups at different Development stages. What this analysis shows, is that there is a lack of dedicated capital development grants for CLH groups, and a lack of access to loan finance which supports revenue expenditure. These things are intuitively known to those supporting the sector. There are more active funders providing development finance, than there are funders supporting Group, Plan and Site functions. We can also identify forms of tenure that are under provisioned.

Perhaps counter to our assumptions, several funders have and do offer funding and finance to help cover the costs of professional services at the Site and Plan stages. Crucially, however, there are no dedicated, national funds directly addressing this for all CLH groups, and therefore the prospect of meeting such costs is an area of great uncertainty for groups. A major gap in the availability of current funding would seem to relate to site acquisition, and how groups obtain the finance to purchase sites.

4.2. The quantity of funding available for each stage

Deciding whether the quantity of current funding is sufficient means deciding whether we are interested in meeting existing, or future demand. This also directs attention to whether the terms or structure of any funding or finance is prohibitive or restrictive for CLH groups (see 4.3 below). Also, without knowing social lenders' total lending capacity, it is hard to define whether the quantum for development finance is enough. What we can do is identify some areas for concern, based on this analysis of the funding and finance landscape:

– **Grant/finance targeting the 'Site' and 'Plan' stages of development:**

CAF Venturesome's CLT social investment Fund provides pre-development loans to CLTs, and the Government's Community Buildings Fund available via Locality also helps meet some of the costs at this stage. However, the total funding available from these sources is not sufficient for many CLH schemes, particularly schemes of over 20 homes, and there is therefore an inadequacy in the total funding available to cover Site and Plan functions. In addition, the second tranche of funding available through Locality requires a secure interest in a site, when the funding is needed precisely for securing a site. There is a patchwork of generic funding that could be used to top up the funding available (e.g. some of Power to Change's funding programmes, Key Fund, Tudor Trust etc), but applying to multiple organisations in this way is a risky and time-consuming endeavor for groups.

- **Staffing complex projects:** There is little dedicated revenue funding to support paid staff within CLH groups. Given what we know about the development of London CLT, LILAC, RUSS, CLT and other larger urban projects, such pioneering schemes demand large investments in time and demand internal capacity. These organisations have tended to draw on ad hoc charitable funding, and other generic sources, in the absence of any dedicated CLH funding to support this.
- **Development grants:** There is a gap in grants for development which can be critical for groups in competitive markets for land and existing housing. The government's biggest funding programme, currently the Shared Ownership and Affordable Homes Programme 2016-21, focuses on housing tenures that many CLH groups will feel do not meet local need. In addition, access to this can require groups to become a Registered Provider, which is an onerous process and puts them at risk of being subject to future changes in housing policy that could have a significant impact on their business model e.g. the Right to Buy or the 1% rent cut.
- **Direct investment in infrastructure:** Few funders are explicitly seeking to support infrastructure bodies. Grants for CLH enabling and support have been obtained from the Oak Foundation, Tudor Trust and Esmée Fairbairn by national and regional infrastructure bodies, but these grants have been made on a relatively ad hoc basis, and concentrated on national or high profile bodies. Even where this funding has been secured, these organisations remain under-resourced. Funders like Big Potential may support infrastructure organisations which can help them prepare for, and access, finance. However, the experience of the CLT Umbrellas has been that between three to five years grant funding is required until sustainability can be achieved and all but one of the Umbrellas was financially fragile at the time of writing.

4.3. The structure of current funding and finance – lessons from the frontline

Irrespective of the quantum of any funds, it might also be asked whether this funding and finance is provided in a way that CLH groups need, or on terms which are sufficiently flexible. In the course of developing this report, we conducted short interviews with three CLH groups in urban areas (the emerging focus of Power to Change's programme). These groups have been anonymised, and are referred to as Group A, B and C. The interviews sought qualitative perspectives on the provision of and difficulties in securing funding and finance and any inadequacies in the current provision. A number of key themes emerged:

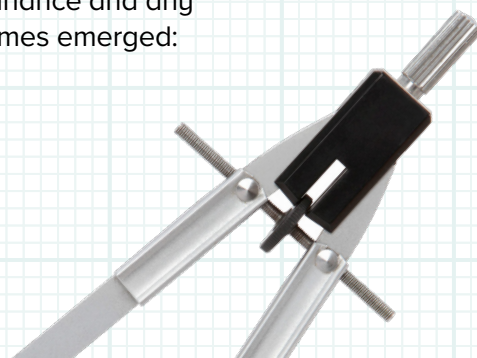

Resources for internal operations and core costs

Those involved in Group A, who recently secured planning permission for a development of over a hundred units, highlighted difficulties in covering their running costs. Crucially, this hampers their community involvement work, in addition to the tasks related to financial management and maintaining good governance arrangements.

Similarly Group B, who sought planning permission for over 30 self-built homes, saw inadequacies in their funding for 'core business costs'. For instance, significant time and effort had been expended in building the capacity and resources to be a 'robust client' in a development process.

The group also identify a lack of funding to cover basic 'back office' functions related to financial and housing management once the dwellings are occupied. Despite receiving significant profile, and attracting various funding sources, the costs of these functions have been difficult to cover.

Site and Plan funding/finance



Current funding and finance does not differentiate, or target, either the Site or Plan stage. Much of this current funding puts restrictive conditions on groups at too early a stage. One interviewee from a co-housing group (Group C), noted how Locality's 'Community Led Project Support' funding set strict conditions on land agreements before providing a grant. The group was due to receive circa £40,000, which would cover the variety of work by professional services up to getting the proposals through planning. Whilst this funding was seen as critical to 'opening everything up' in terms of the proposed development, it was ultimately withdrawn because the group had only a residual six-month agreement left on the site. Furthermore, the Locality 'pre-feasibility' funding, which also covers Group stage functions is only to a maximum of £10,000, so is unlikely to be enough to meet both the Group and Site functions.

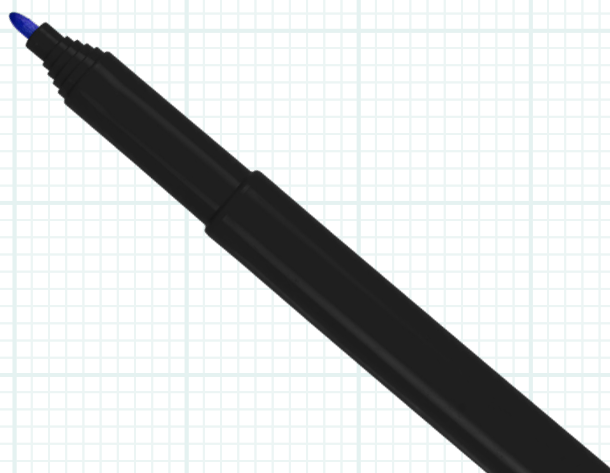

Affordable build finance

Interviewees bemoaned the access to, and conditions of, finance at the Build phase. Group B suggested that they had been forced to look at unsecured loans with interest rates up to 11%. There is loan finance available for groups, but it is sometimes on terms that are not viable. This area merits further investigation, to unpick issues related to unsecured loans.

Group C noted the inadequacies of current development finance when deposits or security are difficult to provide. For instance, where groups are raising capital from future residents (through the sale of their homes), but where such households cannot provide this until they have a home to move into, then there is a funding gap. Few lenders appear to offer such bridging finance, particularly where the loan-to-value ratio is high.

Group A have had to engage with social lenders after other forms of development finance have fallen through. Attempts to secure finance through the Public Works Loan Board have not materialised, requiring engagement with social lenders whose interest rates fail to out-perform the commercial lenders. The group see the need for two stage financing, firstly, a relatively short term loan to get them through development and to the point of occupation, and then a restructured loan on a longer term, low interest basis. Interviewees suggested that only a few social lenders want to provide finance in this way. Again, this assertion needs testing to clarify the underlying problems. There would appear to be potential to innovate in this area, exploring potential to de-risk the investments of funders and lenders, to lower interest rates or meet specific short term needs.

In summary, the message from the frontline of CLH groups is that the conditions on which certain funding and finance is offered can be restrictive, and this relates as much to internal Group functions, as it does to Site, Plan and Build costs.

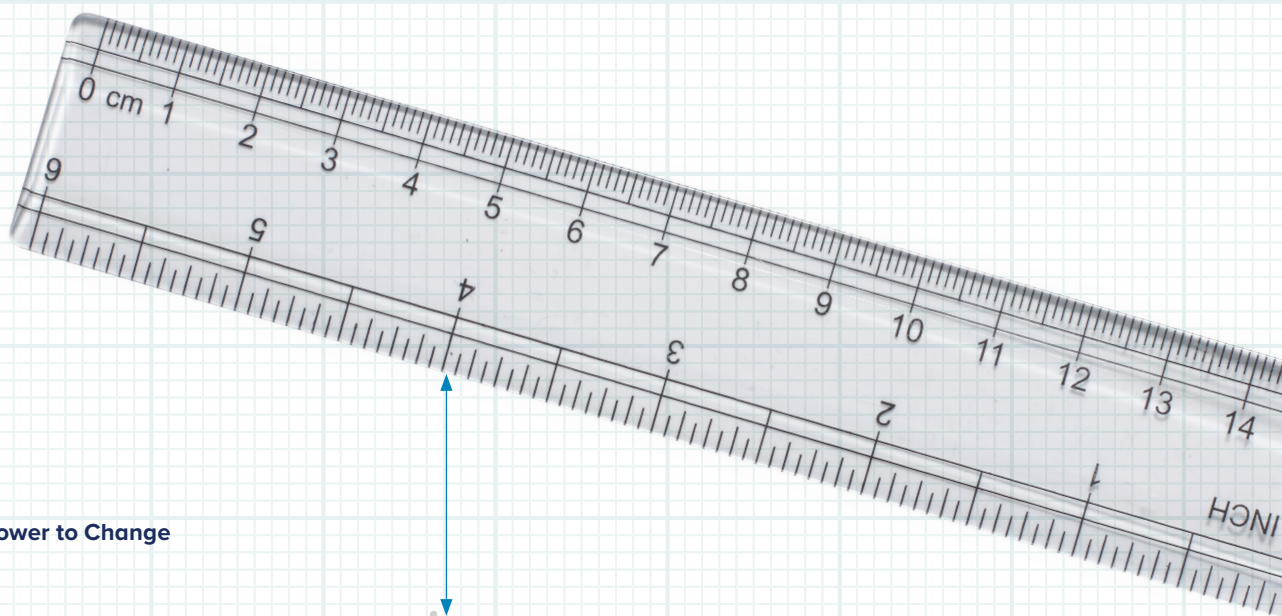

5. Future government funding and the growth of the community-led housing sector

In the Spring Budget 2016 the Government announced the provision of “£60 million of the additional receipts from higher rates on additional residential properties to enable CLH development, including through CLT, in rural and coastal communities where the impact of second homes is particularly acute” (see Budget 2016, page 39, para 1.127). It has since been confirmed that £60 million a year will be available over three years, through the Community Housing Fund. In the first year £60m was distributed to 148 local authorities as both revenue and capital. The local authorities in receipt of the funding have used it to support CLH in a variety of ways.

A number of organisations in the CLH sector have been working with Government on the design of the programme for future years. A single proposal from the sector outlines that, by investing in the national and local enabling infrastructure, providing revenue funding for Site and Plan stages and making available capital funding to enable the delivery of viable and affordable housing schemes, nearly 13,000 additional new affordable homes can be delivered by 2020. Furthermore, by building an infrastructure that is sustainable in the long-term, the sector will continue to grow.

6. Forecasting growth in community-led housing

Estimating how many units the CLH sector will develop by, by 2025, is no easy task. A myriad variables will affect how many groups emerge, and what they can produce.

One way to approach the task of forecasting is to use a current trajectory of growth and make assumptions about whether this will continue, i.e. that if between 2015-20 there is an increase of 50% more units, the period 2020-25 will see a similar growth rate. This assumes that, at the very least, the conditions for CLH will not worsen.

The problem with this method is that we know that output by CLH groups in other countries, and historically in the UK, tends to peak and trough over these longer time frames, particularly as policy and economic conditions change. A preferable method of forecasting is therefore to look at the trajectories of CLH in similar contexts, and at similar points in the growth cycle, and use this as the basis to forecast.

Applying this thinking one might look at the cycle of growth and decline in co-ownership housing in the UK in the 1960s and 1970s, the growth in housing co-operatives in Canada in the 1970s, 1980s and 1990s, and the growth CLTs in the United States (U.S) in the 1990s and 2000s. Crucially, each of the above periods of development were catalysed by national governments creating more conducive conditions for these types of organisation. The Housing Act (1961) and Finance Act (1963), opened up grant funding and tax reliefs for co-ownership. The Canadian Mortgage and Housing Corporation initiated its long-running Co-operative Housing Programme in 1973. And in 1992 the National Affordable Housing Act in the U.S opened the door to federal funding for CLTs. Drawing comparisons with these three periods is valuable as the CLH sector in the UK is witnessing a similar step change in dedicated funding from government, with £300m likely to be made available over the next five years.

When we look at these three periods some general growth patterns can be seen. Roughly calculating how many housing units were developed in each these examples shows that between 900 to 3,300 units were being produced per year.¹ Such estimates undoubtedly miss some units, as in each case other forms of CLH were being developed that were not supported by government and not captured in these figures. There is, therefore, a degree of conservatism in the estimates.

If we assume that the CLH sector in the UK could, with government support, achieve similar levels of development per year, then the growth in CLH stock could look as follows:

¹ We can assume the size of national populations did not have a significant bearing on output in these examples, given the highest annual levels were achieved within the Canadian programme (where the national population was the lowest of the three).

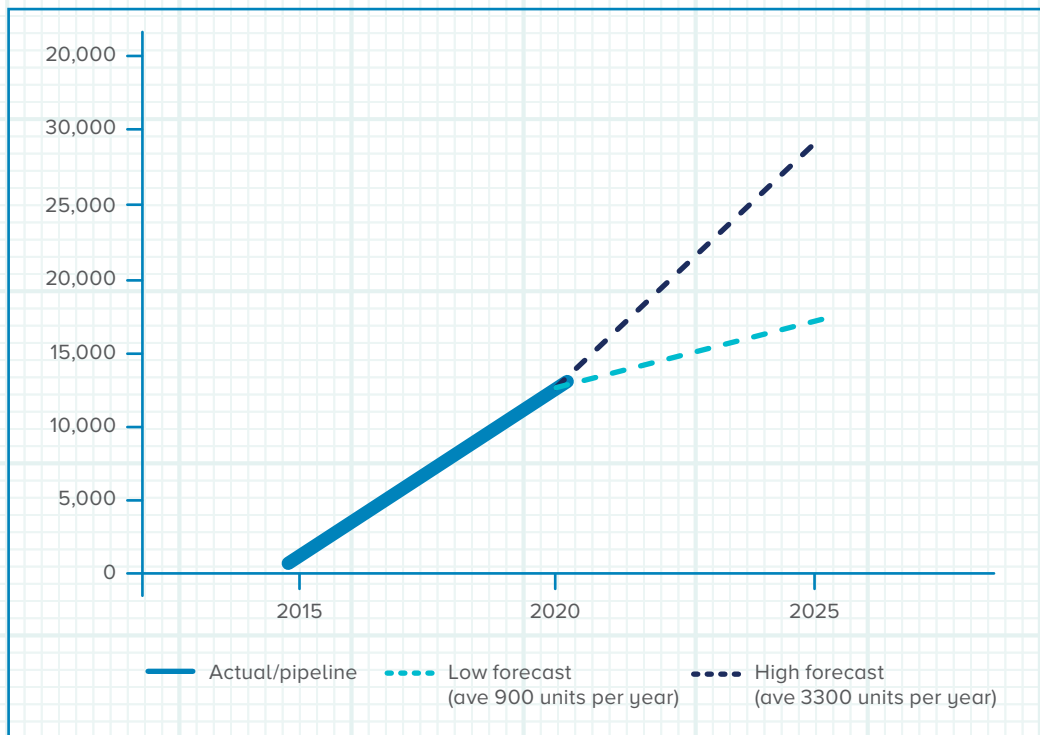

Using data relating to CLH growth in other periods in UK history, and experiences in countries with a similar housing market, policy regimes etc, we can make an informed estimate that between 29,000 and 17,000 CLH units will be developed between 2015-25. This is dependent on conditions remaining conducive. If current rates of growth continue for the next ten years, the cumulative number of units produced will be close to the higher of the forecasts. However, it is possible that growth will plateau, particularly if policy or finance regimes become less generous. However, in November 2017 the Government committed a further £180m to the Community Housing Fund to be spent over the next three years. This, combined with future pipelines and momentum in the sector suggests a continuing growth in CLH output for the foreseeable future.

7. Emerging findings and implications

The analysis above highlights a number of findings which should shape Power to Change's design of the CLH programme. It may also be useful to other funders considering the role they'd like to play in the CLH sector. By setting out standard Development stages for CLH, we have been able to identify particular weaknesses in the provision of funding, finance and other types of support. Broadly speaking these relate to the provision at certain stages of development, the quantum available, and the way that funding and finance is structured. More specifically, we assert that;

- There are notable shortcomings in current funding and support for groups developing their Group functions. What is available is model dependent, with current funding weighted toward CLTs. This means that certain forms of CLH are not being adequately supported and groups may choose the form based on funding availability rather than the best fit for their needs.
- Just as importantly, there are weakness in the current system of financing work carried out at the Site and Plan stage. The amounts of grant available to support these activities is often inadequate in size (particularly for schemes of more than 20 homes) are offered with restrictive conditions, and do not cover the critical costs of land or property acquisition. There is also a question as to whether these stages can be funded through loan finance, given the risk levels.
- Some of these issues – particularly the deficiency at the Group stage – may be addressed by building a sustainable local enabling infrastructure (i.e. 'hubs'), which comprises initial advice and capacity-building for groups, but also has systems for drawing in professional support for Site, Plan and Build. However, Hubs need a stable source of grant funding for at least four years to achieve financial sustainability, and where enabling services are established, newly forming CLH groups will also usually require some initial funding to cover early costs such as incorporation. Power to Change has commissioned research into how such enabling support is best structured, managed and financed

(Delivering a CLH Enabling Hub service: experience and lessons from existing practice, Jo Lavis and Peter Duncan). There is a key role for Power to Change in supporting the development of this localised infrastructure.

- Further investigation is required into the adequacy of ‘Build’ finance, particularly in helping groups as they bridge the period between development expenditure and income generation from rents/sales. There are opportunities to explore how lender’s investments can be de-risked, including through the development of the local enabling infrastructure, so the finance can be offered on more favourable terms.
- There is a need to encourage greater retail mortgage lending to the CLH sector, particularly where homes have a perpetuity arrangement.
- Embedding the Total Process Development stages, outlined above, offers the potential to simplify the process for CLH groups, helping them understand the journey they are on. We recommend that tools are developed to facilitate this. In addition, the Total Process Development stages offers the potential to build a system whereby resources and funding are released to groups on the basis of them meeting set conditions for that stage. For instance, funds could be released for detailed scheme design (a key Plan function) after site agreements have been secured (a key Site function). The Power to Change programme is unlikely to be able to achieve this sort of change to funding CLH on its own, but it could pioneer these changes and encourage both funders and infrastructure bodies to incorporate this thinking into their offers.
- Finally, the use of these Development stages, allied with the knowledge regarding the broad funding and finance landscape for CLH, may allow funders to better co-ordinate their interventions. This might entail certain funders agreeing to target stages of CLH development. Working in such a co-ordinated way will greatly enhance the likelihood of success for many CLH groups.

Appendix 1: Community-led housing development process

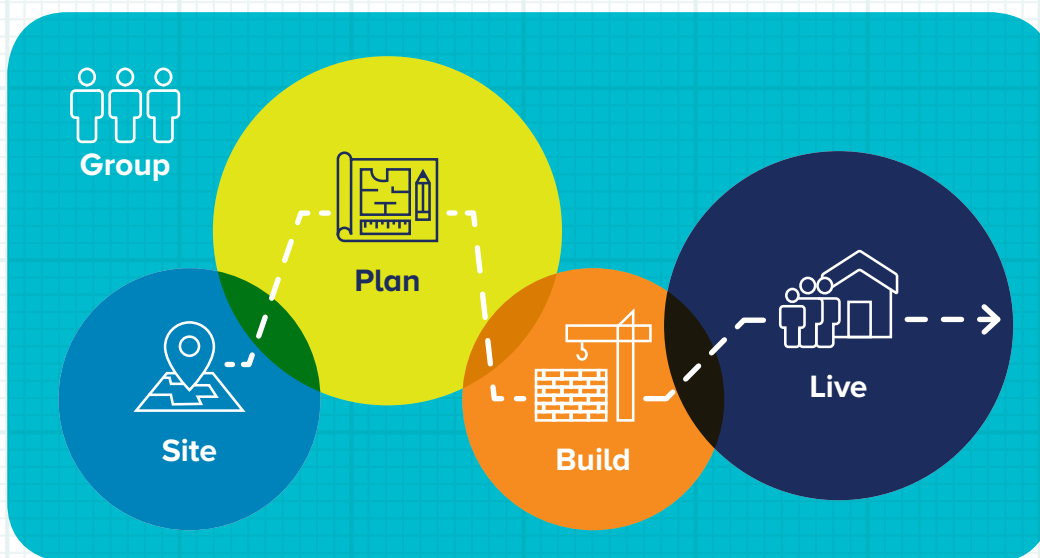

Group



define purpose and common values

accountability/membership

legal constitution options and setting up

democratic/consensus decision making

clarity of roles and responsibilities

development training: costs, risk, tenure options; partnership options; local plan policies/political context; community-led plans/ongoing community engagement

outline business plan and budget

negotiating terms of finance

negotiating partnership terms

ongoing independent support to group throughout project

Site



site finding based on group's criteria

valuation

negotiating an interest in land/property

development appraisal of site/building

pre-planning advice

site investigations

sketch scheme layout

financial feasibility/viability

risk evaluation

competitive bidding/procurement

acquisition options

due diligence

sourcing finance for site purchase/option/lease

Plan



scheme design

working up planning application

financial feasibility/viability update

build options including custom build

specification/Employers Requirements

contract options

negotiating and securing development finance

value engineering

agreements with Local Authority

budgetary control

agreeing contract

Build



building homes and site infrastructure

services provision

cost control – quantity surveyor

quality control – clerk of works

contract management

budgetary control

Live



occupation – rent, own

ongoing management

ongoing budgets – service charges; sinking fund

ongoing membership – sales and relets

democratic/consensus decision making

Appendix 2: Funding and finance landscape

| | Finance | | | | | | Phase | | | Geography | | | Group Type | | Timescales | | Support infrastructure investment | |
|--|---------|---------------|--------------------------|---------|---------------|-----------|-------|-----------|-------|-----------|-----------|--|------------|----------|------------|--------------|-----------------------------------|--|
| | Grant | | | Loan | | | Group | Site/Plan | Build | National | Localised | Targeted | All CLH | Targeted | 2017 | Beyond 2017? | Direct | Indirect (e.g. funds pay for advisor time) |
| | Revenue | Capital (Dev) | Min/Max | Revenue | Capital (Dev) | Min/Max | | | | | | | | | | | | |
| Government funding | | | | | | | | | | | | | | | | | | |
| Community Housing Fund | Y | Y | £6k-£5.1m | N | N | NA | Y | Y | Y | Y | N | Areas of high second home ownership/affordability issues | Y | N | Y | Y | N | Y |
| HCA Shared Owner and Affordable Homes Programme | N | Y | ? | N | N | NA | N | N | Y | Y | N | N | Y | N | Y | Y | N | N |
| Homebuilding Fund | N | N | NA | N | Y | 250k-250m | N | N | Y | Y | N | N | Y | N | Y | Y | N | N |
| Locality Community-led Buildings (Pre-Feasibility) | Y | N | 1k-10k | N | N | NA | Y | N | N | Y | N | N | Y | N | Y | ? | N | Y |
| Locality Community-led Buildings (Project Support) | Y | N | 5k-40k | N | N | NA | Y | Y | N | Y | N | N | Y | N | Y | ? | N | Y |
| National charitable funding | | | | | | | | | | | | | | | | | | |
| CLT Fund (Start up 1,2 & 3) | Y | N | £500-4000k | N | N | NA | Y | N | N | Y | N | N | N | Y | Y | Y | N | Y |
| CLT Fund (Getting to planning) | N | N | NA | Y | N | 0-50k | N | Y | N | Y | N | N | N | Y | Y | Y | N | Y |
| CLT Fund (Building out) | N | N | NA | N | Y | 0-350k | N | N | Y | Y | N | N | N | Y | Y | Y | N | N |
| PtC Bright Ideas | Y | N | 0-20K | N | N | NA | Y | N | N | Y | N | N | Y | N | Y | ? | N | Y |
| PtC Community Business Fund | Y | Y | 50-350k | N | N | NA | N | Y | Y | Y | N | N | Y | N | ? | ? | N | Y |
| Key Fund | Y | Y | 5-150k | Y | Y | 5-150k | Y | Y | Y | N | Y | N | Y | N | Y | ? | N | Y |
| Big Local | Y | Y | >1m in each of 150 areas | N | N | NA | Y | Y | Y | N | Y | 150 Deprived area | Y | N | Y | Y | ? | ? |
| Big Potential (breakthrough & advanced) | Y | N | 20-500k | N | N | NA | Y | Y | ? | Y | N | N | Y | N | Y | Y | Y | Y |

| | Finance | | | | | | Phase | | | Geography | | | Group Type | | Timescales | | Support infrastructure investment | |
|--|---------|---------------|---------|---------|---------------|-------------|-------|-----------|-------|-----------|-----------|-------------------------------|------------|----------|------------|--------------|-----------------------------------|--|
| | Grant | | | Loan | | | Group | Site/Plan | Build | National | Localised | Targeted | All CLH | Targeted | 2017 | Beyond 2017? | Direct | Indirect (e.g. funds pay for advisor time) |
| | Revenue | Capital (Dev) | Min/Max | Revenue | Capital (Dev) | Min/Max | | | | | | | | | | | | |
| Social lenders | | | | | | | | | | | | | | | | | | |
| Triodos | N | N | NA | Y | Y | 0.5m-15m | N | Y | Y | Y | N | N | Y | N | Y | Y | N | N |
| Ecology | N | N | NA | N | Y | £50k to £2m | N | Y | Y | Y | N | N | Y | N | Y | Y | N | ? |
| Charity Bank | N | N | NA | ? | Y | 50k-3.25k | N | ? | Y | Y | N | N | Y | N | Y | ? | N | ? |
| Unity Trust Bank (loans) | N | N | NA | ? | Y | 150K-10m | N | ? | Y | Y | N | N | Y | N | Y | ? | N | ? |
| Resonance Affordable Homes Rental Fund | N | N | NA | ? | Y | 100k-1.2m | N | ? | Y | Y | N | N | Y | N | ? | Y | N | ? |
| Big Issue Invest (Housing Fund) | N | N | NA | ? | Y | 50k-2m | N | ? | Y | N | Y | London | Y | N | Y | ? | N | ? |
| Social and Sustainable Capital (Lending) | N | N | NA | ? | Y | 150k-3m | N | ? | Y | Y | N | N | Y | N | Y | ? | N | ? |
| FSE Group (Socila Impact Accelerator Fund) | N | N | NA | ? | Y | Up to £1m | N | ? | Y | Y | N | N | Y | N | Y | ? | N | N |
| Northstar Ventures (NESIF) | N | N | NA | ? | Y | Up to £1m | ? | ? | Y | N | Y | | Y | N | Y | ? | N | N |
| CAF Venturesome | N | N | NA | Y | Y | | Y | Y | Y | Y | N | N | N | Y | Y | ? | N | N |
| Key Fund (blended grant and loan) | Y | Y | 5-150k | Y | Y | 5-150k | Y | Y | Y | N | N | North of England | Y | N | Y | ? | N | Y |
| CAF Bank | N | N | NA | Y | Y | £50k to £5m | ? | Y | Y | Y | N | N | Y | N | Y | Y | N | N |
| NatWest Social and Community Capital | N | N | NA | ? | Y | £30-750k | ? | ? | Y | Y | N | N | Y | N | Y | ? | N | ? |
| Trust for London | N | N | NA | N | Y | 100k-1m | N | N | Y | N | Y | London: people on low incomes | Y | N | Y | Y | One | N |

| | Finance | | | | | | Phase | | | Geography | | | Group Type | | Timescales | | Support infrastructure investment | |
|---|---------|------------------|------------------------|---------|------------------|-------------|-------|---------------|-------|-----------|-----------|----------|------------|----------|------------|-----------------|-----------------------------------|--|
| | Grant | | | Loan | | | Group | Site/ Plan | Build | National | Localised | Targeted | All CLH | Targeted | 2017 | Beyond 2017? | Direct | Indirect (e.g. funds pay for advisor time) |
| | Revenue | Capital (Dev) | Min/Max | Revenue | Capital (Dev) | Min/ Max | | | | | | | | | | | | |
| Ad Hoc funders (current programmes) | | | | | | | | | | | | | | | | | | |
| Esmee Fairburn (exc. Contributions to CLT Fund) | Y | N | 5k-1.5m | Y | Y | 0-100k | Y | Y | Y | Y | N | N | Y | N | Y | ? | N | N |
| Tudor trust (exc. Contributions to CLT Fund) | Y | Y | Approx ave.50k | N | N | NA | Y | Y | Y | Y | N | N | Y | N | Y | ? | Y | ? |
| Oak Foundation | Y | ? | Previous 400k-1.2m | N | N | NA | N | Y | ? | Y | N | N | Y | N | Y | ? | Y | ? |
| Local funders (major) | | | | | | | | | | | | | | | | | | |
| Cornwall Council | N | N | NA | N | Y | ? | N | N | Y | N | Y | N | N | Y | Y | ? | Y | Y |
| East Cambridgeshire | Y | ? | ? | ? | ? | ? | Y | Y | ? | N | Y | N | N | Y | Y | ? | Y | Y |
| East Devon | N | N | NA | N | Y | ? | N | N | Y | N | Y | N | N | Y | ? | ? | N | ? |
| Leeds City Council (RtB Fund) | N | Y | 30% scheme costs | N | N | NA | N | N | Y | N | Y | N | Y | N | Y | ? | N | Y |

Not included:

Big Lottery community buildings
Nationwide Empty homes/Early support
The Hive
Quartet Community Foundation
Unltd

Appendix 3: SWOT analysis of funding for development stages

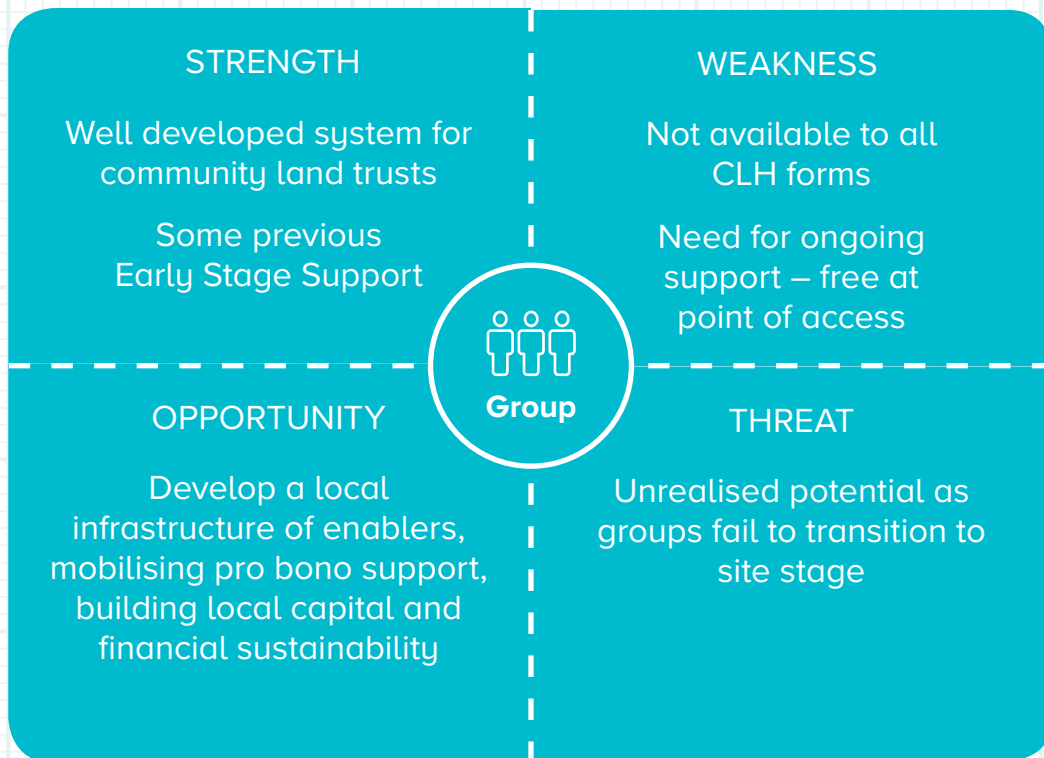





Power to Change

The Clarence Centre
6 St George's Circus
London SE1 6FE

020 3857 7270

info@thepowertochange.org.uk

thepowertochange.org.uk

 [@peoplesbiz](https://twitter.com/peoplesbiz)

Registered charity no. 1159982

Design: supplestudio.com



**NATIONAL
LOTTERY FUNDED**